

REFLECTIVE BEAM SENSOR with integrated amplifier

- ▷ latest LED-Technology
- ▷ very high lateral resolution
- ▷ no additional amplifier
- ▷ minimum mounting space



micro SPOT[®]
micro SPOT is a new and powerful LED technology for miniaturized opto services.

TECHNICAL SENSOR DATA

light type	red 645nm
temperature range	-10°C...+55°C
protection class	IP65

<ul style="list-style-type: none"> • Ø 5mm x 45mm • stainless steel 	RL52RM  <small>actual size</small>
---	--

<ul style="list-style-type: none"> • 6,5mm x 57mm • nickel-plated brass 	RL66RM  <small>actual size</small>
---	--

<ul style="list-style-type: none"> • M6x0,5 x 45mm • nickel-plated brass 	RLM62RM  <small>actual size</small>
--	---

<ul style="list-style-type: none"> • 7mmx8mmx59mm • nickel-plated brass 	RLV74RM  <small>actual size</small>
---	---

<ul style="list-style-type: none"> • 7mmx8mmx59mm • nickel-plated brass 	RLV72RM  <small>actual size</small>
---	---

TECHNICAL DATA

TYP	RL52RM	RLM62RM	RLV72RM	RL66RM	RLV74RM
functional principle	pulsed light				
max. frequency respon.	500Hz				
function indicator	LED red				
operating voltage	10...30 VDC, reverse polarity protection				
current consumption	30mA				
output current	PNP 100mA, short-circuit proof				
sensing distance	max. 50mm on white photographic paper				
	max. 800mm on reflector R35				
power supply cable	2m PUR-cable 3 x 0,09m ²			M8, connector, 3pins	

DIMENSIONS

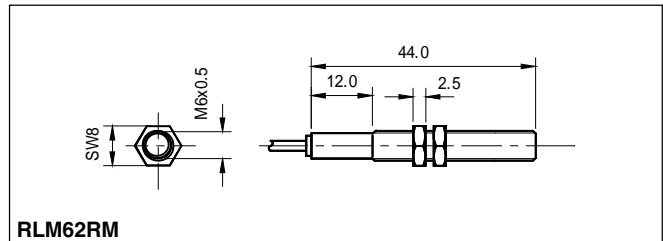
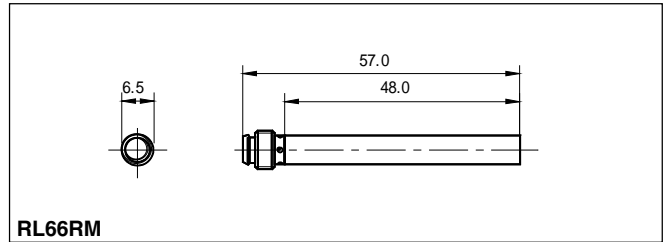
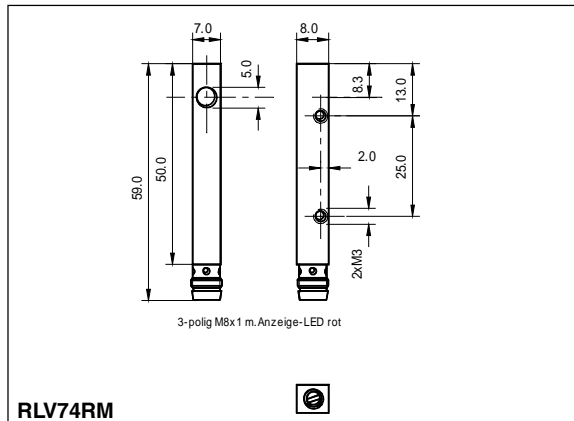
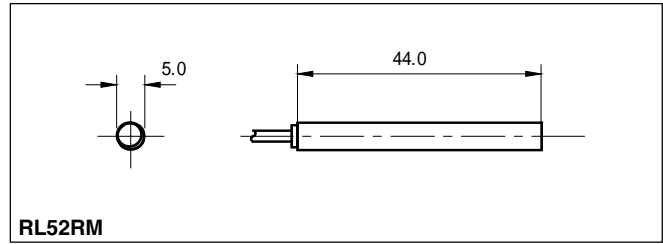
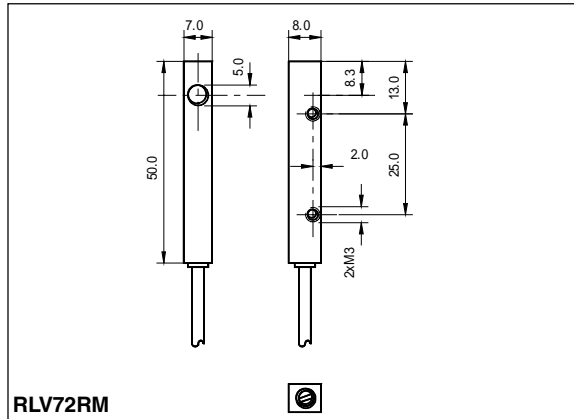

CONNECTION-DIAGRAM

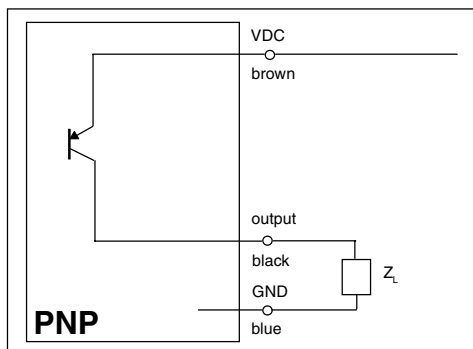

SUPPLY AND OUTPUT

RL52RM - RLM62RM - RLV72RM

brown + VDC
blue - GND
black Signal output

RL66RM - RLV74RM

1 (brown) VDC
4 (black) Signal output
3 (blue) GND

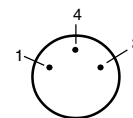

(Anschlusskabel nicht im Lieferumfang enthalten)

PART DESIGNATION

RL52RM-BHP	pulsed	light-on	PNP-output
RLM62RM-BHP	pulsed	light-on	PNP-output
RLV72RM-BHP	pulsed	light-on	PNP-output
RL66RM-BHP	pulsed	light-on	PNP-output
RLV74RM-BHP	pulsed	light-on	PNP-output

RL66RM-BHP and RLV74RM-BHP requires appropriate power supply cable:

VK3G	Power supply cable with plug, locking device (refer to Options)
VK3W	Power supply cable with plug, locking device, angle type

All cables PUR sheathed; standard length 2m; for other dimensions please consult your local distributor.