

FS080-040 • FS080-080 • FS080-120 • FS080-160

STANDARD OPTICAL FRAME SENSOR

- ➔ ideal for part ejection control
- ➔ dynamic working principle
- ➔ resistant against mineral oils
- ➔ robust design, protected optics
- ➔ improved, adjustable resolution

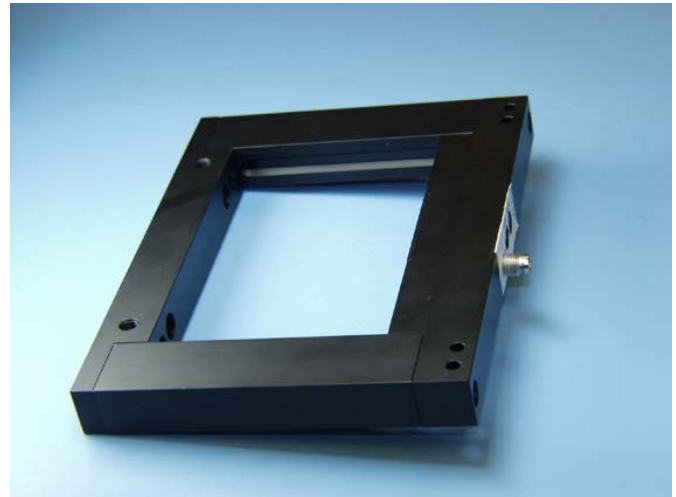

TECHNICAL DATA

TYP	FS080-040	FS080-080	FS080-120	FS080-160
operating voltage	10...30 VDC, reversed polarity protection			
current consumption	40mA	50mA	75mA	90mA
output	PNP or NPN, 200mA, short-circuit proof			
switching function	dark-on, dynamic			
light type	infrared			
operating state indicator	LED green			
function indicator	LED red			
switching delay	400µsec			
pulse stretching	5 ms to 300 ms (adjustable)			
temperature range	-10°C to +55°C			
protection class	IP67			
active window size	80 (active side)x40mm	80 (active side)x80mm	80 (active side)x120mm	80 (active side)x160mm
outside dimensions	90x130x18mm	130x130x18mm	170x130x18mm	210x130x18mm
housing	aluminium, black anodized			
resolution (smallest part)	objects ≥1mm	objects ≥1mm	objects ≥1,2mm	objects ≥1,5mm
counting frequency	function of pulse stretching (max. 200 parts/s)			
plug	01: M8 locking device, 4pins 02: Pigtail 20cm, M12, 4pins			

DIMENSIONS

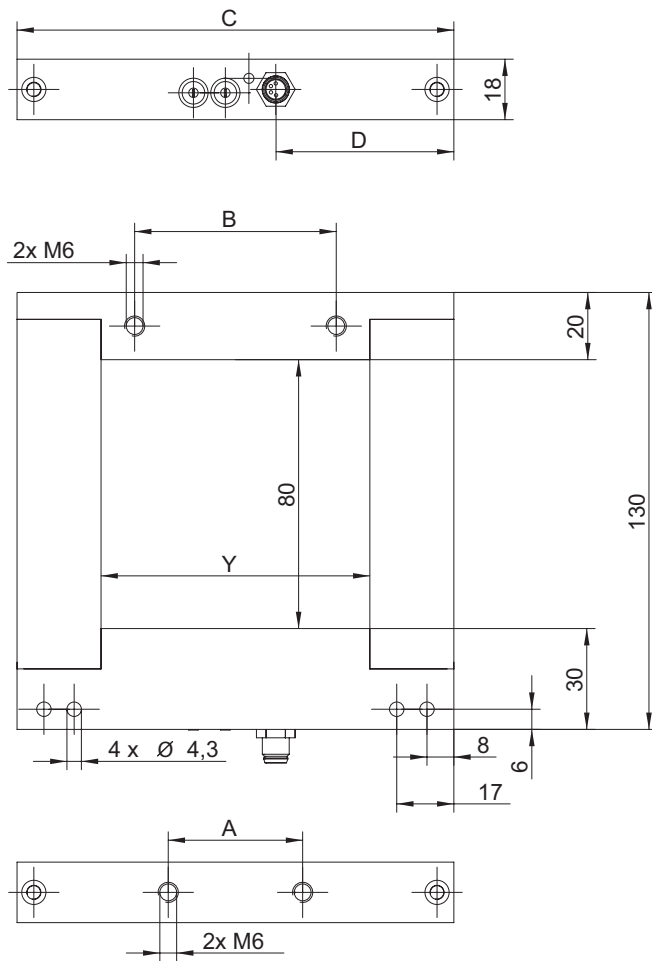

OPERATING CONTROLS

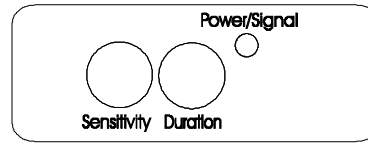

- operating state (Power) LED green
- function indicator (Signal) LED red
- resolution (Sensitivity)
- impuls stretching (Duration)

	FS080-040	FS080-080	FS080-120	FS080-160
Y	40	80	120	160
A	-	40	80	120
B	20	60	100	140
C	90	130	170	210
D	33	53	73	93

CONNECTION DIAGRAM

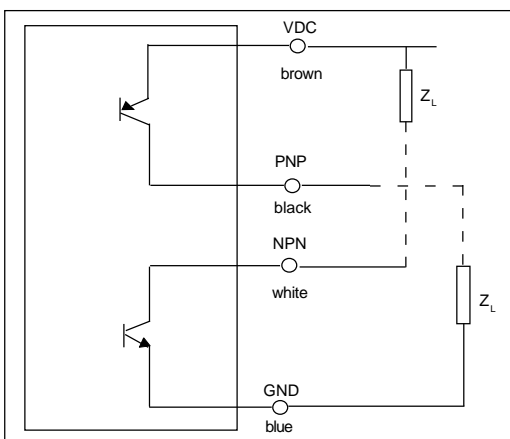

SUPPLY AND OUTPUT

01:
connector M8, 4pins, male

- 1 (brown) + VDC
- 2 (white) NPN output
- 3 (blue) - GND
- 4 (black) PNP output

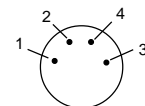

02:
cable 20cm with connector M12, 4pins, male

- 1 (brown) + VDC
- 2 (white) NPN output
- 3 (blue) - GND
- 4 (black) PNP output

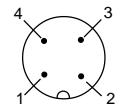

PART DESIGNATION

FS080-040-DP/N-01:	continues light	Dark-on	PNP + NPN-output	M8, 4pins
FS080-040-DP/N-02:	continues light	Dark-on	PNP + NPN-output	M12 Pigtail, 4pins
FS080-080-DP/N-01:	continues light	Dark-on	PNP + NPN-output	M8, 4pins
FS080-080-DP/N-02:	continues light	Dark-on	PNP + NPN-output	M12 Pigtail, 4pins
FS080-120-DP/N-01:	continues light	Dark-on	PNP + NPN-output	M8, 4pins
FS080-120-DP/N-02:	continues light	Dark-on	PNP + NPN-output	M12 Pigtail, 4pins
FS080-160-DP/N-01:	continues light	Dark-on	PNP + NPN-output	M8, 4pins
FS080-160-DP/N-02:	continues light	Dark-on	PNP + NPN-output	M12 Pigtail, 4pins